

2" Inlet (internal thread)

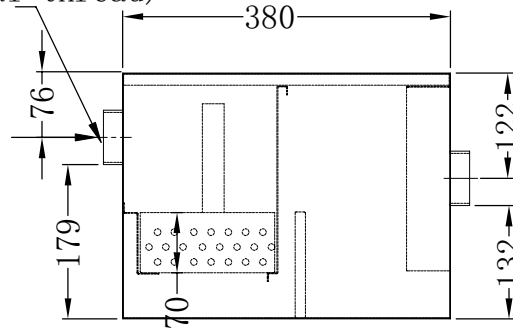

2" Inlet
(internal thread)

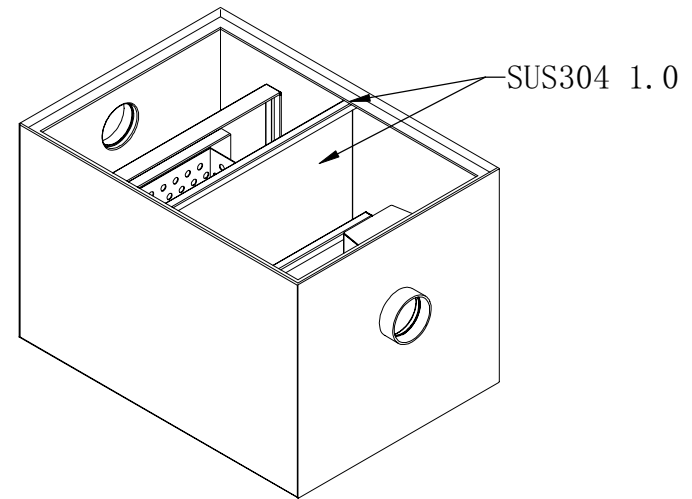
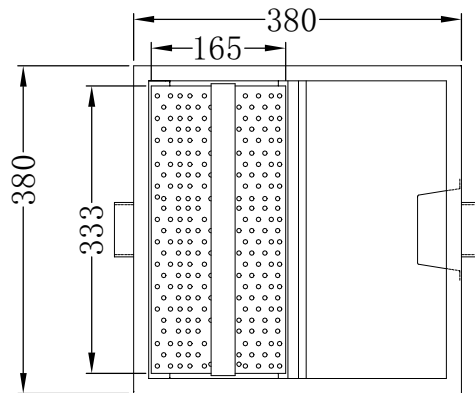
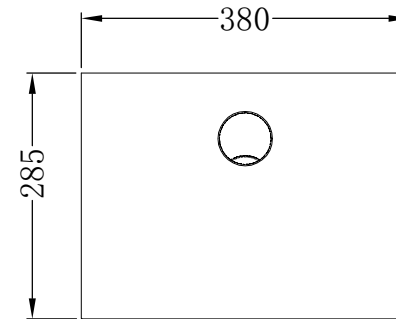

ONLY FOR CONFIRMATION



DRAWN	DATE	CHECK	DATE	ITEM NO.:	REV NO.
H1	2022-04-24		20	7490.0315	